

# U.S.SAWS™

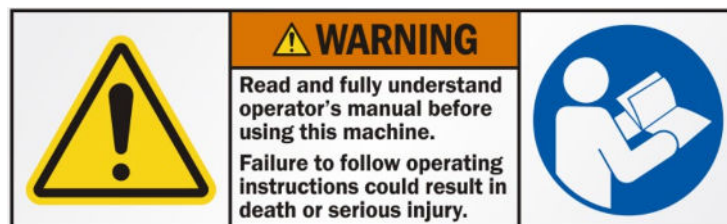

## U.S.SAWS CC - SERIES OPERATING MANUAL



### Notice of Copyright Protection

Copyright 2020, by U.S.SAWS . All rights reserved. This work may not be reproduced or disseminated in whole or in part by any means without the prior written permission of U.S.SAWS

04-14-2021

# U.S.SAWS™

**SURFACE PREP  
DIVISION**

P: 877-817- 6687 F: 813-621-7125  
Visit us at [www.ussaws.com](http://www.ussaws.com)  
[sales@ussaws.com](mailto:sales@ussaws.com)



# INTRODUCTION & SPECIFICATIONS

## 1.0 INSTRUCTIONS FOR USE OF MANUAL SECTIONS

Section	Page
Table of Contents & Introduction .....	2
Symbols & Decals .....	3
Safety Instruction .....	4 - 5
Pre-Operation Checklist .....	6 - 7
Operation .....	8
Parts Breakdown .....	9 - 12
Warranty & Service .....	13 - 14

### Foreword/Introduction

The owner's manual is intended to point out some of the basic safety situations that maybe encountered during the normal operation & maintenance of the CC-100 Crack Chaser Machine & to instruct you in safety practices for dealing with these conditions. Keep all manuals provided with your machine in a safe place at all times.

The information and specifications included in this publication were in effect at the time of approval for printing. U.S.SAWS reserves the right, however, to discontinue or change specifications or design at any time without notice and without incurring any obligation.

The U.S.SAWS CC-100 is a gas powered crack chasing saw that is designed to rout out random cracks in concrete and asphalt surfaces prior to filling with a repair product or sealant. The CC-100 is intended to be used on parking garages, runways and large open warehouses. The CC-100 will cut up to 1" deep and up to 1/2" wide. Always operate this machine in a well ventilated area, as it emits carbon monoxide fumes, which are colorless and odorless and can kill. Read this manual in it's entirety prior to operating the machine and make sure to follow all safety regulations. Since safety regulations vary between different countries and states, you must contact the proper authorities and follow all appropriate regulations.

Read this entire operations and maintenance manual before using your new tool. Pay close attention to the Rules for safer operation,

### Dangers, Warnings and Cautions.

The purpose of safety symbols and explanations are to attract your attention to possible hazards and how to avoid them. The safety symbols and explanations do not by themselves eliminate any danger. The instructions or warnings they give are not substitutes for proper accident prevention measures.



**DANGER:** Indicates an imminently hazardous situation that if not avoided, will result in death or serious injury. This signal word is limited to the most extreme situations.



**WARNING:** Indicates a potentially hazardous situation that, if not avoided, could result in death or serious injury.



**CAUTION:** Indicates a potentially hazardous situation that, if not avoided may result in minor or moderate injury. It may also be used to alert against unsafe practices that may cause property damage.

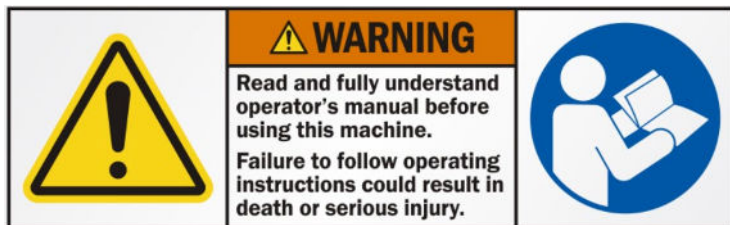

## 2.0 SPECIFICATIONS

Model	CC-100
Part Number	SX90102
Description	Walk-Behind Crack Chaser
Power Source	Honda GX270
Max RPM	7,500
Max Cutting Depth	1"
Blade Diameter	6" Dry Diamond
Blade Width	.250", .375", .500"
Blade Arbor	5/8" with Drive Pin Hole
Weight	150 lb



# SYMBOLS & DECALS

## 3.0 SYMBOLS & DECALS

### For Safe Operation

You must be qualified for safe operation of the U.S.SAWS CC-100 machine. You must clearly understand the written instructions supplied by U.S.SAWS, be trained - including actual operation - & know the safety rules & regulations for the job site. It is a safety practice to point out & explain safety signs & practices to others & to make sure they understand the importance of following these instructions.

### Be Safe

Human error is the result of many factors: carelessness, fatigue, sensory overload, preoccupation, unfamiliarity with the machine or attachments, or drugs or alcohol, to name a few. You can avoid serious injury or death caused by these & other unsafe work practices. Be safe and never assume accidents cannot happen to you.

For your safety and the safety of others, act safely and encourage your fellow workers to act safely as well.



Read and understand operator's manual before using this machine. Failure to follow operating Instructions could result in injury or damage to equipment.



Use only diamond blades (steel centered diamond cutting-off wheels) with this machine. RPM rating on blade must exceed machine max rpm rating. The use of any other blade could result in death or serious injury.

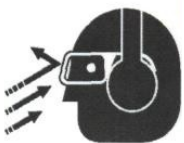

Flying debris and loud noise hazards. Wear ear and eye protection



Engine exhaust contains poisonous carbon monoxide gas. Breathing it could cause death. Operate machine in well ventilated area.



**AVOID INJURY.**  
Do NOT operate with guard removed. Replace guard before operating machine.



Wear safety boots when operating this machine



Wear appropriate clothing



Wear Head Protection, breathing protection, and the use of hearing protection is mandatory



Wear hand protection



Wear proper electrostatic grounding equipment at all times. Static discharge during fueling can cause explosion

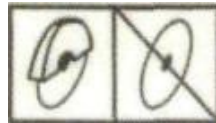

Keep all guards in place



Rotating blade hazard. Do NOT operate with guard up. Keep hands and feet away.



**TO AVOID INJURY.**  
Always inspect saw blades before use. Replace all cracked or damaged blades.



# SAFETY INSTRUCTIONS

## 4.0 SAFETY INSTRUCTIONS

### 4.1 KNOW THE RULES & YOUR EQUIPMENT.

**Most job sites have rules governing equipment use & maintenance. Before starting at a new work location, check with the supervisor or safety coordinator. Ask about any rules or regulations you need to abide.**

**OSHA enforces federal laws within the United States that apply to the safe operation, application, & maintenance of equipment on job sites. It is the employer's responsibility to comply with these laws.**

Do not operate this machine unless you have read the operations and maintenance manual carefully. Read any additional instructions included from other manufacturers and organizations such as Honda® and the Masonry and Concrete Saw Manufacturers Institute. Learn the applications and limitations as well as the specific potential hazards related to this tool

### 4.2 RECEIVE PROPER TRAINING.

Do not operate this machine unless you have received operational and maintenance training from a U.S.SAWS representative or from an authorized distributor for U.S.SAWS.

### 4.3 PROTECT YOUR FEET.

Observe all applicable local, state and federal safety regulations. Wear OSHA approved foot protection.

### 4.4 PROTECT YOUR EYES.

Observe all applicable local, state and federal safety regulations. Wear OSHA approved safety glasses.

### 4.5 PROTECT YOUR LUNGS.

Breathable silica may be generated by use of this product. Silica can cause severe and permanent lung damage, cancer, and other serious diseases. Do not breathe the dust. Do not rely on your sight or smell to determine if the dust is in the air. Silica may be in the air without a visible dust cloud. If air monitoring equipment for silica is not provided by your employer at your work site, you **MUST** wear appropriate respiratory protection when using or servicing the machine. Consult your employer and OSHA regarding the appropriate respiratory protection.

### 4.6 PROTECT YOUR HEARING.

Observe all applicable local, state and federal safety regulations. Wear OSHA approved hearing protection.

### 4.7 DRESS PROPERLY.

Do not wear loose clothing or jewelry that can be caught in moving parts. Wear protective hair covering to contain long hair. Keep hair away from motor air vent. Rubber gloves and non-skid footwear are recommended when working outdoors

### 4.8 AVOID A DANGEROUS ENVIRONMENT.

Do not expose machine to rain. Do not use machine in wet conditions. Keep work area well lit. When working at an elevated location, pay attention to articles and persons below.

### 4.9 BEWARE OF HIDDEN DANGERS IN CONCRETE.

Rebar or utility lines may be buried in concrete. Disconnect the power to any utility lines. If these items are to be missed, clearly mark the area. If these items are to be cut, check the blade manufacturer's guidelines on material to be cut.

### 4.10 AVOID ANY AREAS OR ACTIONS THAT EXPOSE YOU TO CARBON MONOXIDE.

Exhaust gas from gasoline engines contains dangerous carbon monoxide. Breathing it can cause unconsciousness and even kill you. Always operate gasoline engine machines in a well-ventilated area. Do not operate in areas where exhaust fumes could accumulate without wearing appropriate respiratory protection. Consult your employer and OSHA

regarding use of appropriate respirator for dangerous carbon monoxide gases.

### 4.11 KEEP WORK AREA CLEAN. DO NOT RUN OVER ANYTHING.

Loose objects could be thrown from crack. Make sure area to be cut is clear from people and any loose objects, nuts, bolts, etc. Never run over any loose objects.

### 4.12 KEEP CHILDREN AND VISITORS AWAY.

Do not allow anyone to stand in line with the blade path. Do not let children or visitors contact machine or extension cord. Keep children and visitors away from the work area.

### 4.13 AVOID FLAMMABLE LIQUIDS OR GASES.

Engines and diamond blades produce heat and sparks during operation. Never use machines in dangerous sites containing flammable, combustible or explosive materials such as lacquer, paint, benzene, thinner, gasoline, gases, and adhesive agents.

### 4.14 AVOID CONTACT WITH HOT MUFFLER.

The muffler becomes hot during operation and remains hot after stopping the engine. Do not touch the muffler while it is hot. Let the engine cool before storing indoors. Do not place flammable objects close to the engine.

### 4.15 AVOID CONTACT WITH HOT BLADE AND BLADE GUARD.

The blade and blade guard become hot during operation and remain hot after stopping the engine. Do not touch the blade and blade guard without proper hand protection.

### 4.16 KEEP FIRM GRIP ON MACHINE.

During normal operation as instructed in Section 6.0, keep a firm hold on the handle grips and maintain control of the machine until the blade completely stops.

### 4.17 SHUT OFF ENGINE.

When not in use, before servicing and when changing accessories shut off engine. Release the lever switch and move the on/off switch to the OFF position. Move the fuel valve lever to the OFF position.

### 4.19 CHECK BLADE AND MACHINE ROTATION DIRECTION.

Never operate a blade in the wrong rotation direction. Check the machine rotation direction and blade direction when mounting a blade.

### 4.20 CHECK BLADE MAXIMUM ALLOWABLE SPEED.

Check the maximum operating speed of the machine and blade. Never use a blade rated less than the machine's maximum speed rating.

### 4.21 CHECK BLADE FOR CRACKS, DAMAGE, AND MISALIGNMENT.

Never use a cracked, damaged, or misaligned blade. After mounting blade, rotate by hand to check for proper alignment.

### 4.22 CHECK DIAMOND BLADE FOR WARNINGS.

Many diamond blades contain a chemical known to the state of California to cause cancer and/or birth defects or other reproductive harm. Diamond blades improperly used are dangerous. Comply with American National Standards Institute Safety Code B71 and Occupational Safety & Health Act covering SPEED, SAFETY GUARDS, FLANGES, MOUNTING PROCEDURES, GENERAL OPERATING RULES, HANDLING, STORAGE & INSPECTION AND GENERAL MACHINE CONDITIONS. Read Diamond Blades Safety Manual before use.

### 4.23 DO NOT FORCE WRONG SIZE OR TYPE BLADE ONTO MACHINE.

Do not force a blade onto the machine shaft or alter the size of the arbor-mounting hole. Be certain that the drive pin is in place through the blade when tightening the blade nut. Never add a drive pin hole or modify a blade.

### 4.24 USE CORRECT SAW AND ACCESSORIES.

Do not force a small saw to do the job of a heavy-duty saw. Do not use the saw for improper applications. Never cut material for which the blade was not designed. Check blade manufacturer's guidelines on material to be cut.



# SAFETY INSTRUCTIONS

## 4.25 STORE IDLE EQUIPMENT.

The machine, blades and tools should be stored in a dry and secure location when not in use. Keep equipment out of reach of children.

## 4.26 DO NOT FORCE SAW.

The saw will do the job better and safer at the rate for which it was designed.

## 4.27 OBTAIN SAFETY DATA SHEET (SDS) FOR ALL WORK SURFACE MATERIALS.

This includes primers, all coatings, adhesives, tile and crack filling materials, etc. Do not attempt to cut, clean out or remove material without SDS information. Consult SDS sheet for hazards information. Be aware that some materials are explosive as a dust.

## 4.28 DO NOT OVERREACH.

Keep proper footing and balance at all times.

## 4.29 MAINTAIN MACHINE WITH CARE.

Keep machine clean and follow maintenance procedures for better and safer performance. Keep handles dry, clean, and free from oil and grease. Follow instructions for lubricating and changing accessories.

## 4.30 REMOVE ADJUSTING TOOLS.

Form a habit of checking to see that tools such as adjusting wrenches are removed from the machine and properly stored before starting the engine.

## 4.31 STAY ALERT.

Watch what you are doing. Use common sense. Do not operate machine when you are tired or fatigued.

## 4.32 DO NOT USE DRUGS, ALCOHOL, MEDICATION.

Do not operate machine while under the influence of drugs, alcohol, or any medication.

## 4.33 KEEP THE RIGHT PARTS IN THE RIGHT POSITIONS.

Do not operate machine with parts missing or improperly mounted.

## 4.34 CHECK DAMAGED PARTS.

Verify all machine guards are in good condition and will function properly before using the machine. Check for alignment of moving parts, binding of moving parts, breakage of parts, mounting, and any other conditions that may affect machine operation. A guard, power switch or other part that is damaged should be properly repaired or replaced by an authorized service center unless indicated elsewhere in this instruction manual. Do not operate machine if lever or engine on/off switch does not function properly.

## 4.35 SECURELY MOUNT ACCESSORIES AND BLADES TO THE MACHINE.

Extra care must be taken when using saws on an elevated location to prevent injury to someone on a lower level in the event the tool or accessory should drop. Do not operate without fall protection for operator and debris protection for public.

## 4.36 NEVER TOUCH THE MOVING PARTS.

Never touch moving parts such as blades, belts and others.

## 4.37 STOP OPERATION IMMEDIATELY IF ANY ABNORMALITY IS DETECTED.

Stop using machine immediately if any abnormalities are observed during operation. Examples of abnormalities include unusual noise and vibration.

## 4.38 WHEN REPLACING A PART, USE THE SAME TYPE AND QUALITY.

When replacing a component part with a new one, use only the same type and quality of new part. Never attempt to repair a machine if you are unfamiliar with proper procedures and techniques required.

## 4.39 REFUEL WITH CARE.

Gasoline is extremely flammable. Gasoline vapor can explode. Refuel outdoors, in a well ventilated area, with the engine in the OFF position. Never smoke near gasoline and keep other flames and sparks away. Always store gasoline in an approved container. If any gasoline is spilled, make sure the area is dry before starting the engine.

## 4.40 NEVER DISABLE THE LEVER.

Do not modify, disable, or attempt to permanently engage the lever. Do not operate a machine if lever is not functioning. This could lead to serious injury or death.

## 4.41 LOAD AND UNLOAD SAFELY.

Use proper heavy lifting procedures. Read & understand manuals before loading & unloading.

## 4.42 STORAGE.

Always store equipment properly when it is not being used. Equipment should be stored in a clean, dry location and out of reach of children.

## 4.43 SAVE THESE INSTRUCTIONS.

Refer to this operations and maintenance manual as well as any additional instructions included from other manufacturers and organizations such as Honda® and the Masonry and Concrete Saw Manufacturers Institute®. Never permit anyone to operate the machine without proper instructions.



## DUST WARNING

**Cutting, especially when DRY cutting, generates dust that comes from the material being cut, which frequently contains silica.**

Silica is a basic component of sand, quartz, brick clay, granite and numerous other minerals and rocks. Exposure to excessive amount of such dust can cause:

- Respiratory diseases (affecting your ability to breath), including chronic bronchitis, silicosis and pulmonary fibrosis from exposure to silica. These diseases may be fatal;
- Skin irritation and rash; and
- Cancer according to NTP\* and IARC\*

\* National Toxicology Program, International Agency for Research on Cancer

Take precautionary steps

- Avoid inhalation of and skin contact with dust, mist and fumes;
- Wet cut when feasible, to minimize dust;
- Wear and ensure that all bystanders wear appropriate respiratory protection such as dust masks designed to filter out microscopic particles. (See OSHA 29 CFR Part 1910.1200)

California Prop 65 Warning: Use of this product can cause exposure to materials known to the State of California to cause cancer and/or birth defects or other reproductive harm.



# PRE-OPERATION CHECKLIST

## 5.0 PRE-OPERATION CHECKLIST



Read and understand operator's manual before using this machine. Failure to follow operating instructions could result in injury or damage to equipment.

Figure 1 - Warning label - read and understand manual

5.1 Start by reading the entire Honda Engines Owner's Manual, Rx for Diamond Blade Safety, and Rx for Concrete Saws by the Masonry and Concrete Saw Manufacturers Institute. Then, read the entire CC-100 operations and maintenance manual. Get familiar with the machine's parts.

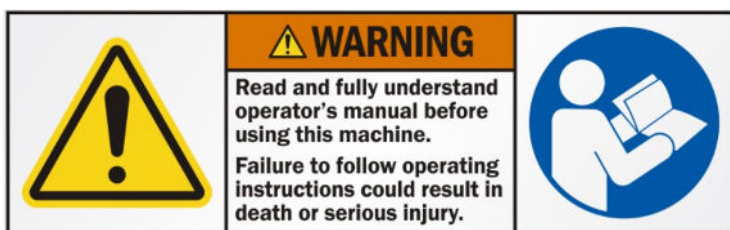

TO PREVENT SERIOUS INJURY DO NOT OPERATE SAW WITHOUT PROPER TRAINING AND UNDERSTANDING OF THE OWNERS MANUAL WHEN OPERATING THIS MACHINE

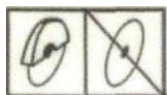

Keep all guards in place



Wear Head Protection, breathing protection, and the use of hearing protection is mandatory



Flying debris and loud noise hazards. Wear ear and eye protection



Wear hand protection



**WARNING:** Improperly maintaining the CC-100 including the Honda engine or failing to correct a problem before operation could cause a malfunction resulting in a serious injury. Always perform a pre-operation inspection before each operation and correct any problem. See Honda Engines Owner's Manual.

5.2 Check the condition of the Honda engine. See the section titled "Before operation - is your engine ready to go?" in the Honda Engines Owner's Manual.



### AVOID STATIC ELECTRICITY RISK WHEN FUELING

**WARNING:** Ultra-Low Sulfur Diesel (ULSD) poses a greater static ignition hazard. Consult with your fuel or fuel system supplier to ensure the delivery system is in compliance with fueling standards for proper grounding and bonding practices. Maintaining a discharge strap must be connected to any U.S.SAWS vacuum at all times when equipment is being used.



Wear proper electrostatic grounding equipment at all times. Static discharge during fueling can cause explosion



**WARNING:** Exhaust gas from gasoline engines contains dangerous carbon monoxide. Breathing it can cause unconsciousness and even kill you. Always operate gasoline engine machines in a well-ventilated area. Do not operate in areas where exhaust fumes could accumulate without wearing appropriate respiratory protection. Consult your employer and OSHA regarding use of appropriate respirator for dangerous carbon monoxide gases. See Figure 7.



Engine exhaust contains poisonous carbon monoxide gas. Breathing it could cause death. Operate machine in well ventilated area.

Figure 2 - Warning label - engine exhaust contains carbon monoxide gas

5.3 Observe the condition of your work environment. Walk over area work area and look for hazards. Make sure the work environment is safe and meets all safe-working conditions discussed in section 4, Rules for safer operation.

5.4 Obtain SAFETY DATA SHEET (SDS) for all work surface materials. This includes primers, all coatings, adhesives, tile and crack filling materials, etc. Do not attempt to cut, clean out, or remove material without SDS information. Consult SDS sheet for health hazards information. Be aware that some materials are explosive as a dust



Use only diamond blades (steel centered diamond cutting-off wheels) with this machine. RPM rating on blade must exceed machine max rpm rating. The use of any other blade could result in death or serious injury.

Figure 3 - Warning label - use only diamond blades



# PRE-OPERATION CHECKLIST

## 7,500 MAX. RPM

**5.5** Verify that the lever is disengaged or released, and the Honda engine switch and fuel valve lever are in the OFF position. Make sure blade is completely stopped.



**CAUTION:** Running the CC-100 generates heat in the engine, blade and blade guard. Do not touch these components without wearing proper heat protecting work gloves.



### **TO AVOID INJURY.**

Always inspect saw blades before use. Replace all cracked or damaged blades.

**Figure 4 - Warning label - inspect blades before use**

**5.6** Check for missing or loose bolts. Tighten loose bolts and replace missing bolts before operating machine.



**CAUTION:** The blade depth is approximate and not exact. Many variables affect the exact blade depth such as the exact diameter of a worn diamond blade. If an accurate depth must be cut, install the blade to be used with the engine in the OFF position. Place the CC-100 in a secure position that allows the blade to overhang and be visibly measured at full blade depth. An example would be blocking the wheels with the engine in the OFF position and lowering the blade along side a street curb. This will allow a measurement from the bottom of the blade to the top of the curb.



**WARNING:** Breathable silica may be generated by use of this product. Silica can cause severe and permanent lung damage, cancer, and other serious diseases. Do not breathe the dust. Do not rely on your sight or smell to determine if the dust is in the air. Silica may be in the air without a visible dust cloud. If air monitoring equipment for silica is not provided by your employer at your work site, you **MUST** wear appropriate respiratory protection when using or servicing the machine. Consult your employer and OSHA regarding the appropriate respiratory protection.



# OPERATION

## CAUTION

**CAUTION:** Running the CC-100 generates heat in the engine, engine muffler, blade and blade guard. Do not touch these components without proper heat protecting work gloves.

### 6.1 Removing and installing the blade

**6.1.1** With engine in the OFF position, loosen the clamping knob and remove both 1-1/2" blade change wrenches from the CC-100 handle.

**6.1.2** Remove bolt in the blade guard holding bracket. Hold the blade guard firmly and raise guard up into the holding bracket. Reinsert bolt in the blade guard holding bracket and tighten nut.

**6.1.3** Place one wrench on the drive flange to hold the blade shaft in place. Place the other wrench on the blade nut and turn counter-clockwise to loosen the nut.

**6.1.4** Unscrew the blade nut. Slide the outer flange, spacers and blade off the shaft.

**6.1.5** Replace blade, spacers, and outer flange. Outer flange pin must line up with all spacers and drive flange to fit through properly.

## WARNING

**WARNING:** Be sure that the flanges, and blade are clean and undamaged before mounting. Do not use damaged parts. The CC-100 maximum blade operating speed is 7500 rpm as labeled on the blade guard. The CC-100 shaft diameter is 1 inch. Therefore, only use dry cut diamond blades rated for higher than 7500 rpm maximum safe speed and designed for 1-inch diameter shafts. Using a non dry cut diamond blade or a blade rated below 7500 rpm could result in severe blade failure, personal injury or death. See Figure 28 and Figure 29. Never cut material for which the blade was not designed. Check blade manufacturer's guidelines on material to be cut. Never operate a blade in the wrong rotation direction. Verify blade direction when changing blades.

**6.1.6** Screw on and tighten the blade nut with wrenches making sure the face is flat against the outer flange. The blade shaft should be flush or slightly stick out beyond the blade nut to ensure all the blade nut threads are engaged. The outer flange pin should not touch the CC-100 chassis and 1/2" hex bolts when rotating. Rotate blade by hand to verify proper clearance and that the blade runs true (without wobbling). See Figure 30 and Figure 31. Never use a blade with interference or that does not run true.

**6.1.7** Always run a CC-100 with the blade guard in the down position.

## WARNING

**WARNING:** Breathable silica may be generated by use of this product; Silica can cause severe and permanent lung damage, cancer, and other serious diseases. Do not breathe the dust. Do not rely on your sight or smell to determine if the dust is in the air. Silica may be in the air without a visible dust cloud. If air monitoring equipment for silica is not provided by your employer at your worksite, you MUST wear appropriate respiratory protection when using or servicing the machine. Consult your employer and OSHA regarding the appropriate respiratory protection.

### 6.2 Adjusting dust brush height and 2 inch blade guard caster wheel

**6.2.1** The dust brush should firmly touch the ground to prevent excessive dust from escaping into the surrounding work area.

**6.2.2** With engine in the OFF position, loosen the 3/8-inch hex nut by turning it clockwise. Then turn the caster adjustment nut counterclockwise to lower the dust brush or clockwise to raise the dust brush.

**6.2.3** With the dust brush in the desired position, tighten the 3/8-inch hex nut by turning it counterclockwise.

### 6.3 Checking and adjusting belt tension

**6.3.1** The belt tension should be checked after the first hour of operation on a new CC-100 or new belt. On a used CC-100, the belt tension should be checked once a day. With engine in the OFF position, remove the four 5/16" hex bolts that attach the belt guard to the chassis.

**6.3.2** Remove the belt guard. The belt should deflect no more than 1/16" under moderate finger pressure equidistant between the sheaves.

**6.3.3** To tighten the belt, loosen the four 5/16" hex nuts that hold the Honda engine to the chassis. Then, turn the 3/8" hex head bolt clockwise on the front of the CC-100.

**6.3.4** After reaching the desired belt tension, verify that the belt sheaves are properly aligned and the belt is straight. Retighten the four 5/16" hex nuts that hold the engine against the chassis.

**6.3.5** Replace the belt guard with the four 5/16" hex bolts that were removed in step 6.3.1. Never run a CC-100 without the belt guard in place.

### 6.4 Bearing lubrication

**6.4.1** With engine in the OFF position, slowly tilt the CC-100 back until the handle rests on the ground.

**6.4.2** These bearings are exposed to excessive dust and require the same brand of high quality grease as supplied by the factory. Apply ALVANIA® Grease 3 with a hand grease gun to both flanged bearings on the blade shaft after every 100 hours of use.

**6.4.3** The performance of the bearing is greatly influenced by the quantity of grease. For optimum performance, insert grease until a little bleeds out from between the outer ring raceway and the perimeter of the slinger. Wipe off excess grease.

**6.4.4** Slowly tilt the CC-100 forward until all wheels are back on the work surface.

### 6.5 Honda engine maintenance

**6.5.1** See the section titled "Servicing your Honda engine" in the Honda Engines Owner's Manual. This section includes detailed information on:

**6.5.1.1** The importance of maintenance

**6.5.1.2** Maintenance safety and precautions

**6.5.1.3** Maintenance schedule

**6.5.1.4** Refueling

**6.5.1.5** Engine oil level check, oil change, and recommendations

**6.5.1.6** Air filter inspection

**6.5.1.7** Air cleaner service

**6.5.1.8** Sediment cup cleaning

**6.5.1.9** Spark plug service

**6.5.1.10** Idle speed adjustment

### 6.6 Transportation

**6.6.1** Allow the CC-100 blade guard, blade, engine, and engine muffler to cool.

**6.6.2** See the section titled "Helpful tips and suggestions - Transporting" in the Honda Engines Owner's Manual.

**6.6.3** With engine in the OFF position, securely strap down CC-100 to shipping pallet, trailer bed, etc. in normal upright position.

### 6.7 Troubleshooting

**6.7.1** See the three sections titled "Helpful tips and suggestions, Taking care of unexpected problems, and Technical and consumer information" in the Honda Engines Owner's Manual.

**6.7.2** See Rx for Diamond Blade Safety by the Masonry and Concrete Saw Manufacturers Institute for diamond blade troubleshooting.





# PARTS BREAKDOWN

6.8 Figure 18 CC-100 SERIES SAWS

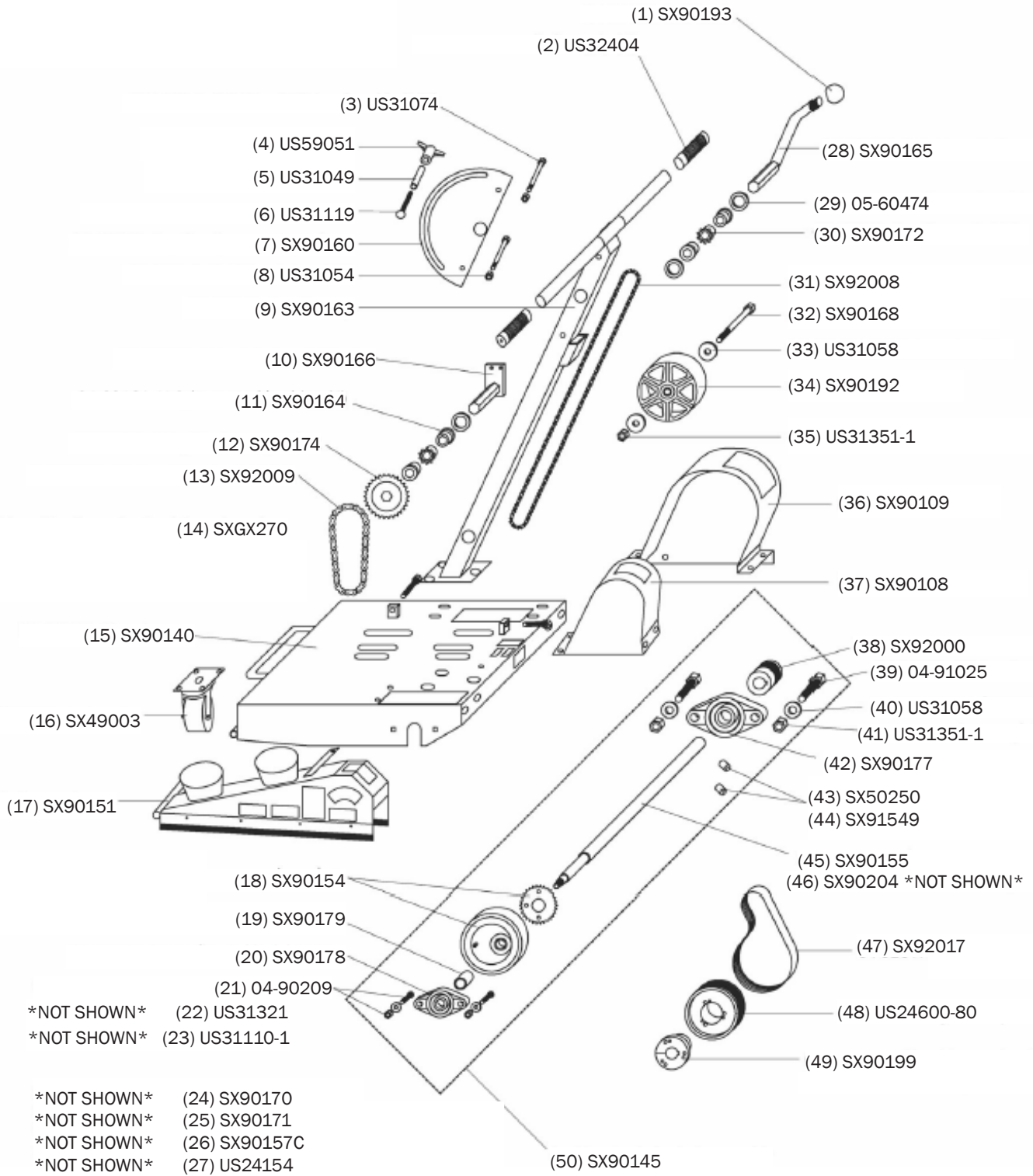

# PARTS BREAKDOWN

ITEM	QUANTITY	PART NUMBER	DESCRIPTION
1	1	SX90193	BALL KNOB
2	2	US32404	RIBBED HANDLE GRIP
3	2	US31074	1/4-20 X 2-3/4" HEX HEAD BOLT
4	1	US59051	TWO ARM CLAMPING KNOB 5/16-18
5	1	US31049	SPANNER BUSHING 3/8ID X 1/2OD X 1-9/16 LONG
6	1	US31119	5/16-18X2 COACH BOLT
7	1	SX90160	DEPTH ADJUSTMENT QUADRANT ASSEMBLY
8	2	US31054	1/4"-20, THIN HEX NYLON-INSERT LOCKNUT, ZNC-PLTD,
9	1	SX90163	HANDLE ASSEMBLY
10	1	SX90166	RETURN SPRING SHAFT ASSEMBLY
11	4	SX90164	HEIGHT CONTROL BUSHING
12	1	SX90174	1/2" HEX BROACHING & SET SCREW
13	1	SX92009	CHAIN 21-3/8" LONG
14	1	SXGX270	GX270: 8.5HP HONDA HORIZONTAL SHAFT GAS ENGINE
15	1	SX90140	CHASSIS
16	1	SX49003	SWIVEL CASTER
17	1	SX90151	BLADE GUARD ASSEMBLY
18	1	SX90154	DUNCAN BEARING W/ SPROCKET ASSEMBLY AND UPDATED CHASSIS FLANGE REPLACEMENT
19	1	SX90179	WHEEL SPACER
20	1	SX90178	20MM FLANGE BLOCK BEARING
21	1	US31115	5/16-18 X 1" CARRIAGE BOLT
22	1	US31321	5/16 WIDE FLAT WASHER
23	1	US31110-1	5/16-18 NYLON LOCK NUT
24	2	SX90170C	INNER DRIVE FLANGE W/ BLACK OXIDE
25	2	SX90171	OUTER FLANGE WITH PIN
26	1	SX90157C	FLANGE NUT
27	2	US24154	1 1/2" HEAVY DUTY WRENCH 12" LONG
28	1	SX90165	HEIGHT CONTROL HANDLE ASSEMBLY
29	11	US31337	3/8" FLAT WASHER
30	2	SX90172	SMALL SPROCKET W/ 1/2" BORE
31	1	SX92008	CHAIN - 35 SERIES 48-1/2"L
32	1	SX90168	OUTER WHEEL AXLE
33	4	US31058	1/2"HARDENED SAE FLAT WASHER
34	1	SX90192	OUTER WHEEL
35	5	US31351-1	1/2"-13 NYLOCK NUT
36	1	SX90109	BELT GUARD
37	1	SX90108	CHAIN GUARD



# PARTS BREAKDOWN

ITEM	QUANTITY	PART NUMBER	DESCRIPTION
38	1	SX92000	BLADE SHAFT PULLEY
39	1	US31351-2	1/2"-13 X 1-1/2" HEX HEAD BOLT
40	1	US31058	1/2"HARDENED SAE FLAT WASHER
41	1	US31351-1	1/2"-13 NYLOCK NUT
42	2	SX90177	FLANGE BEARING 2 BOLT 1" BORE
43	1	SX50250	1/4"-20X3/8" SOCKET SET SCREW
44	1	SX91549	1/4"-20X1/2" SOCKET SET SCREW
45	1	SX90155	CC SHAFT REVG
46	1	SX90204	JS-110 3/16"X1/4'X1-1/2" KEYSTOCK
47	1	SX92017	POLY V-BELT
48	1	US24600-80	MOTOR PULLEY
49	1	SX90199	QD BUSHING 1"
50	1	SX90145	BLADE SHAFT ASSEMBLY



# RECOMMENDED BLADES



**WARNING:** Recommended accessories for this tool including blades are listed in this manual or are available by calling customer service. The use of any other attachment or accessory might be hazardous.

**6.8** CC-100 premium dry cut diamond blades, medium bond

<b>Table 1</b> - Dry cut diamond blade list (* All blades listed are designed with CC-100 drive pin holes)	
<b>Part Number</b>	<b>Description</b>
SX90102	CC-100 9 HP Honda gas powered stand up crack chasing saw with vacuum hose adapter.
CCB06250PD	6"x.250"x5/8" Rectangular Segments with DPH and Kicker Segments
CCB06375PD	6"x.375"x5/8" Rectangular Segments with DPH and Kicker Segments
CCB06500PD	6"x.500"x5/8" Rectangular Segments with DPH and Kicker Segments
CCB06250PVD	6"x.250"x5/8" "V" Shaped Segments with DPH and Kicker Segments
CCB06375PVD	6"x.375"x5/8" "V" Shaped Segments with DPH and Kicker Segments
CCB06500PVD	6"x.500"x5/8" "V" Shaped Segments with DPH and Kicker Segments

<b>Blade Cutting Speeds</b>			
1/2" Depth	1/4" Width	Concrete	12ft/min.
1/2" Depth	1/4" Width	Concrete	10ft/min.
1/2" Depth	3/8" Width	Concrete	8-10 ft/min.
1/2" Depth	1/4" Width	Asphalt	15ft/min.
1/2" Depth	1/4" Width	Asphalt	15 ft/min.
1/2" Depth	3/8" Width	Asphalt	10-12ft/min.



# WARRANTY AND SERVICE

## 7.0 WARRANTY AND SERVICE

### 7.1.1 Warranty

This document is to be used as a guide in determining warranty policies and procedures for U.S.SAWS and its U.S.SAWS products. It is to be used in determining whether a warranty is justified and as a procedural guide in completing a U.S.SAWS warranty claim form.

### 7.1.2 Warranty Responsibility

The distributor or the end user must prepare a Machine Warranty Information Card when the machine is delivered. Failure to comply will make any and all warranties on this equipment null and void. Credit for warranty repairs will be given only after receipt of the WARRANTY CLAIM FORM, properly completed with all the required details. Submittal details are described later in this document.

### 7.1.3 Warranty Policy

**7.1.3.1** U.S.SAWS warrants its U.S.SAWS products against defects in material and workmanship under normal and proper use for a period of one year (365) days from the date of delivery; in the case of Rental Fleet Machines, date of assignment to Rental Fleet. Such warranty is extended only to the buyer who purchases the equipment directly from U.S.SAWS or its authorized distributor. This warranty does not include expendable parts such as, but not limited to, plugs, cutters, blades, blast wheel, wear parts, liners and seals.

**7.1.3.2** The obligation under this warranty is strictly limited to the replacement or repair, at US SAWS's option, of machines and does not include the cost of transportation, loss of operating time, or normal maintenance services.

**7.1.3.3** This warranty does not apply to failure occurring as a result of abuse, misuse, negligence, corrosion, erosion, normal wear and tear, alterations or modifications made to the machine without express written consent of U.S.SAWS .

**7.1.3.4** Warranty request must be submitted in writing within thirty (30) days after failure.

**7.1.3.5** Written authorization to return merchandise under warranty must first be obtained from U.S.SAWS .

**7.1.3.6** U.S.SAWS reserves the right to inspect and make the final decision on any merchandise returned under warranty.

**7.1.3.7** U.S.SAWS offers no warranty with respect to accessories, including but not limited to, engines, motors, batteries, electrical boards, tires and any other parts not manufactured by us but which the original manufacturer warrants.

**7.1.3.8** U.S.SAWS reserves the right to make product changes or improvements without prior notice and without imposing any obligation upon itself to install the same on its products previously sold.

**7.1.3.9** The above warranty conditions can only be altered by US SAWS. US SAWS must confirm alterations in writing for each specific transaction.

**7.1.3.10** U.S.SAWS reserves the right to establish specific warranty terms for used or demo machines on an individual transaction basis. Invoices covering such merchandise will clearly state the provisions of the applicable warranty for each specific transaction.

**7.1.3.11** WE DO NOT AUTHORIZE ANY PERSON, REPRESENTATIVE OR SERVICE OR SALES ORGANIZATION TO MAKE ANY OTHER WARRANTY OR TO ASSUME FOR US ANY LIABILITY IN CONNECTION WITH THE SALE OF OUR PRODUCTS OTHER THAN THOSE CONTAINED HEREIN.

**7.1.3.12** UNDER NO CIRCUMSTANCES SHALL US SAWS BE LIABLE TO CUSTOMER OR ANY OTHER PERSON FOR ANY DIRECT, INCIDENTAL, OR CONSEQUENTIAL DAMAGES RESULTING FROM THE USE OF THE PRODUCT OR ARISING OUT OF ANY BREACH OF ANY WARRANTY OR FOR ANY SPECIAL OR CONSEQUENTIAL DAMAGES OF ANY CHARACTER, INCLUDING WITHOUT LIMITATIONS, DAMAGES FOR ANY LOSS OF GOODWILL, WORK STOPPAGE, OR ANY AND ALL OTHER COMMERCIAL DAMAGES OR LOSSES.

**7.1.3.13** U.S.SAWS MAKES NO OTHER WARRANTIES, EXPRESSED OR IMPLIED, INCLUDING, BUT NOT LIMITED TO, THE IMPLIED WARRANTIES OF MERCHANTABILITY AND FITNESS FOR A PARTICULAR PURPOSE WITH RESPECT TO THE US SAWS PRODUCTS SOLD PURSUANT THERETO.



# MACHINE WARRANTY INFORMATION CARD

**TO ENSURE THE PROPER WARRANTY COVERAGE IS EXTENDED TO THE OWNER OF THIS MACHINE, FILL OUT THE ATTACHED CARD COMPLETELY AND ACCURATELY.**

## **WARRANTY REGISTRATION CARD**

IMPORTANT! To ensure that your U.S.SAWS machine is covered under warranty, please fill in the following information and mail or fax it to U.S.SAWS, 8004B E. Broadway Ave. Tampa, FL 33619, Fax No. 714-434-7299

<b>COMPANY</b>
<b>NAME</b>
<b>ADDRESS</b>
<b>INTENDED USE</b>
<b>DATE OF PURCHASE</b>
<b>INTENDED USE</b>
<b>SERIAL NUMBER</b>

If you are not the owner of record as shown on the manual copy of the warranty registration card, do not operate this machine before contacting U.S.SAWS at 1-866-987-7297 Verify the following before operating the equipment:

## **CHANGE OF OWNER OR NEW ADDRESS REGISTRATION CARD**

IMPORTANT! To ensure that your U.S.SAWS machine is covered under warranty, please fill in the following information and mail or fax it to U.S. SAWS, 8004B E. Broadway Ave. Tampa, FL 33619, Fax No. 714-434-7299

<b>COMPANY</b>
<b>NAME</b>
<b>ADDRESS</b>
<b>INTENDED USE</b>
<b>DATE OF PURCHASE</b>
<b>INTENDED USE</b>
<b>SERIAL NUMBER</b>

14

**U.S.SAWS™**

**SURFACE PREP  
DIVISION**

P: 877-817-6687 F: 813-621-7125  
Visit us at [www.ussaws.com](http://www.ussaws.com)  
[sales@ussaws.com](mailto:sales@ussaws.com)

